

✿ 研究方向: 液晶技術應用與光纖元件的開發，將液晶材料延伸應用於可調式光電元件、新穎光纖元件與感測器等領域。

1. 液晶生化感測器-Liquid crystal-based Biosensor
2. 液晶光纖干涉元件-Liquid Crystal-based Fiber Mach-Zehnder Interferometer
3. 藍相液晶/高分子複合材料於在光電元件應用的開發 - Long period fiber grating, Fresnel lens, grating
4. 液晶分子在中空光纖內的配向技術與應用
5. 電控液晶光電元件的技術開發-Smart window, tunable polarizer, liquid crystal Fresnel lens, microlens, laser,.....

液晶生化感測器

➤ 向列型液晶 (Nematic liquid crystal)

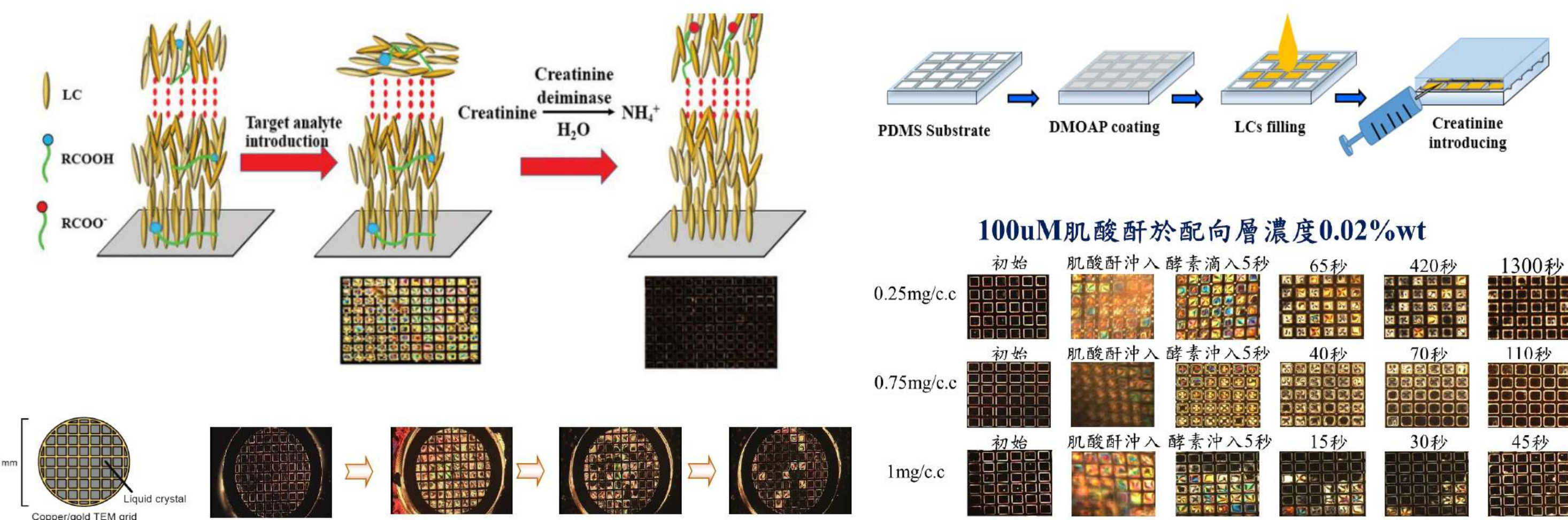

➤ 膽固醇液晶高分子 (Cholesteric liquid crystal polymer)

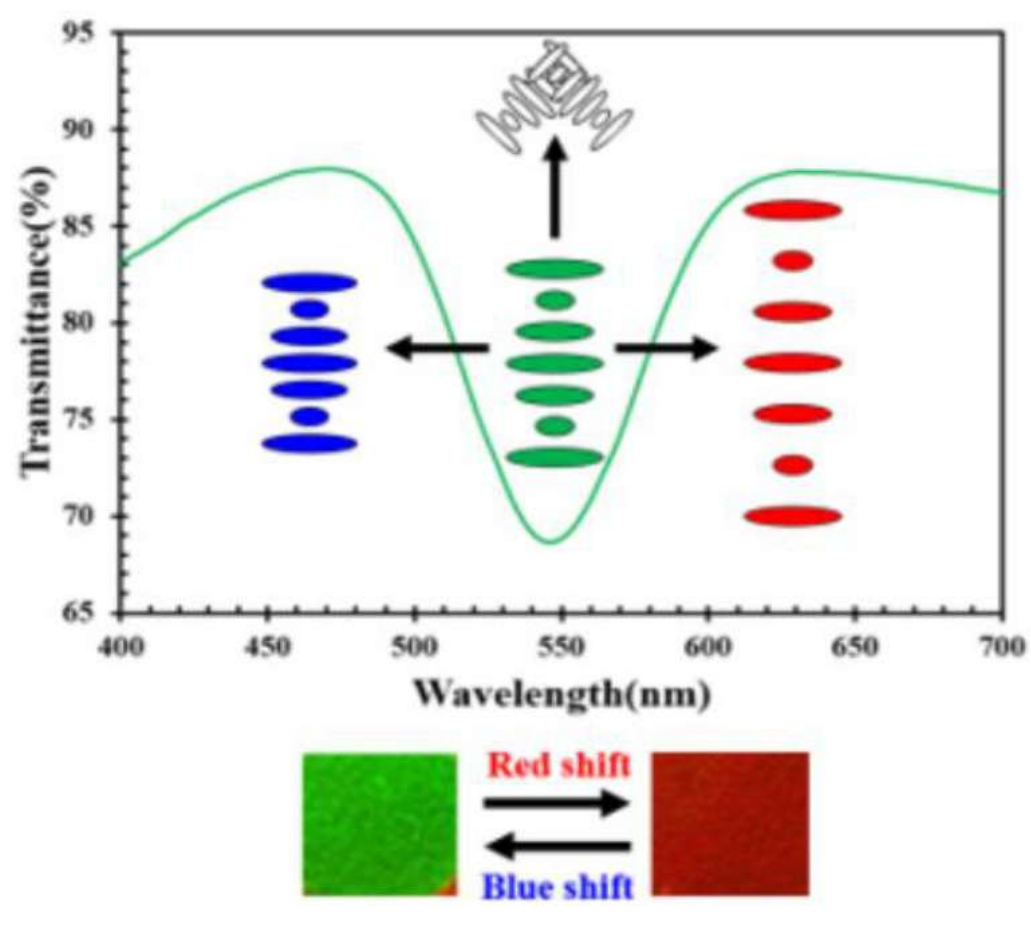

➤ 電紡絲膽固醇液晶纖維膜 (electrospun-CLC film)

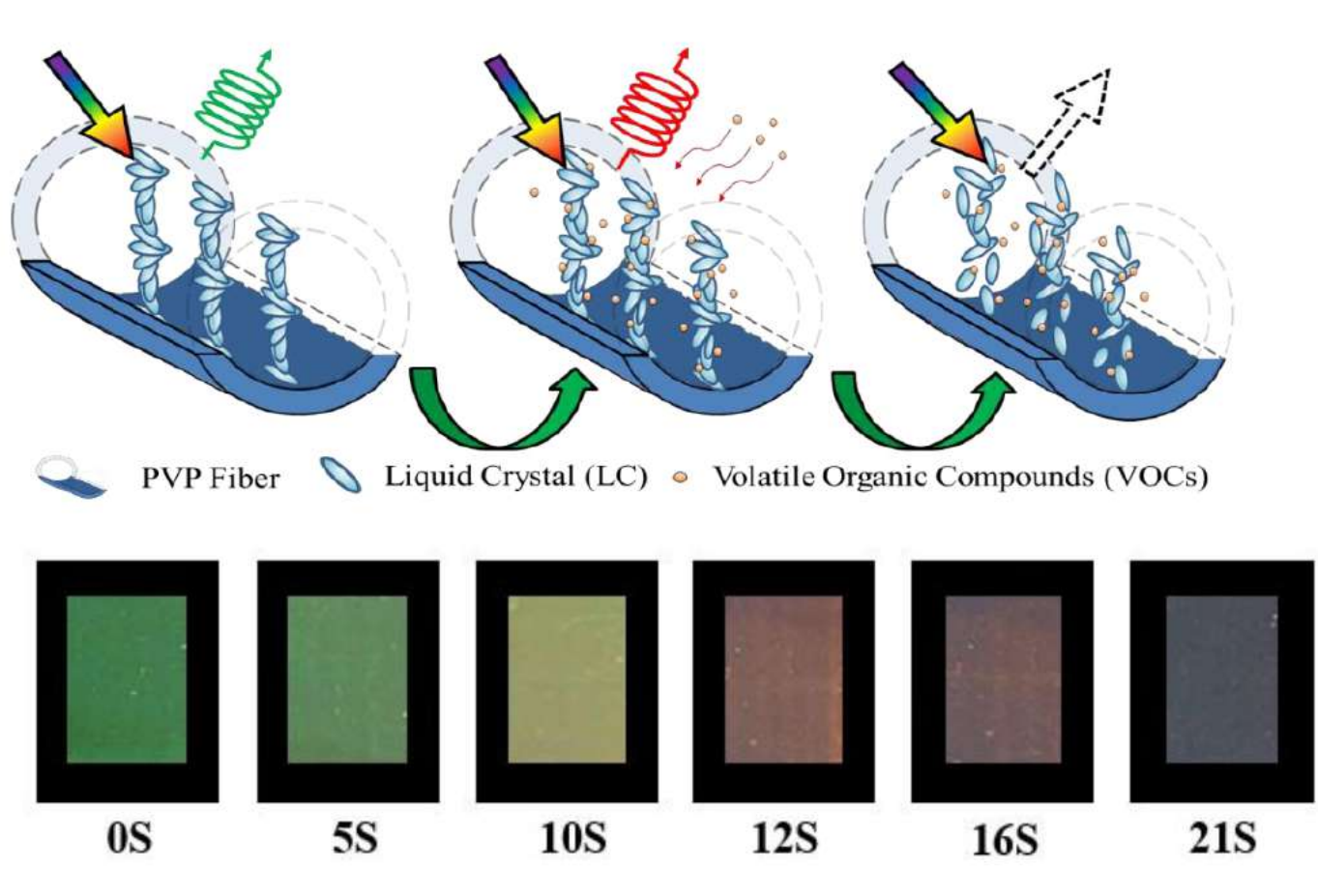

液晶光纖干涉元件

➤ Liquid Crystal-based Fiber Mach-Zehnder Interferometer

High sensitive sensors for temperature, curvature, electric field, RI, material thermal expansion

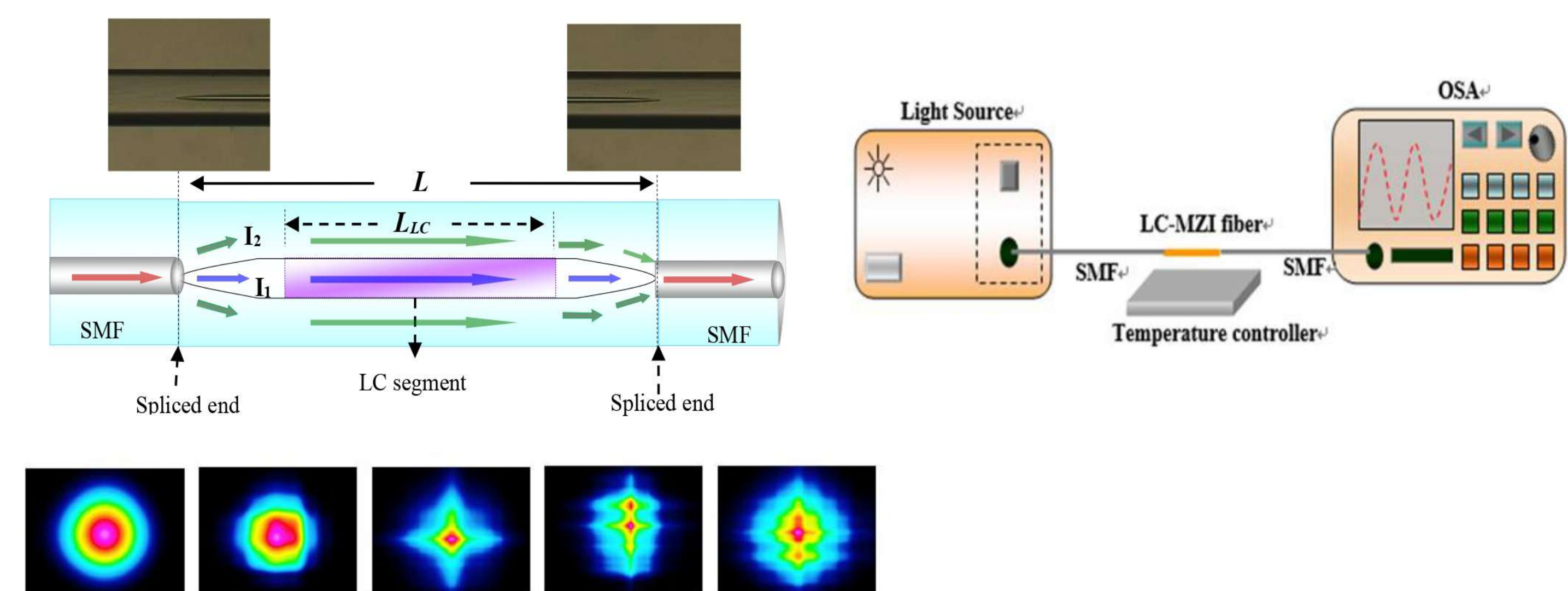

➤ Thermal effect

The refractive index of LC can be changed by the temperature or by a relatively low voltage.

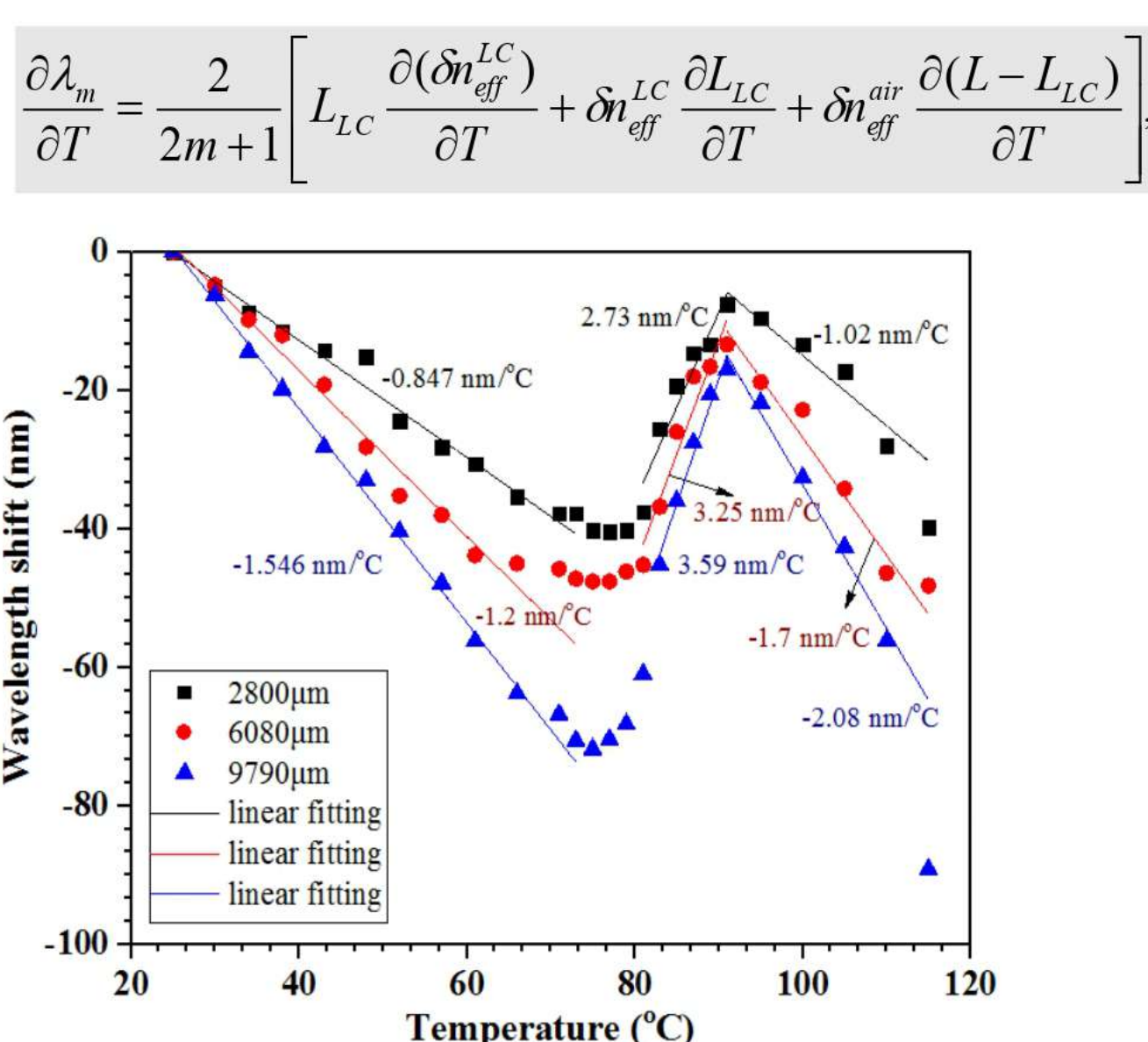
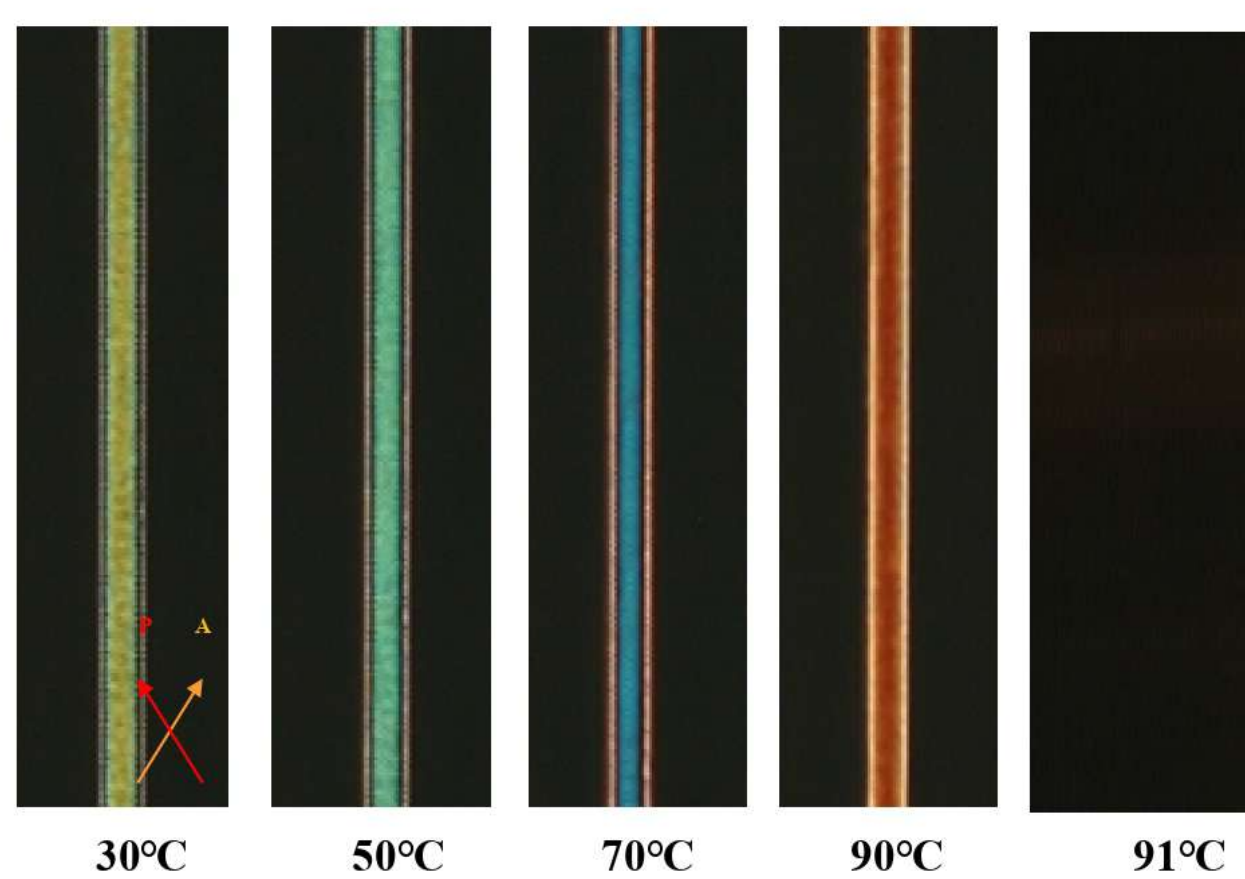

➤ Electrically tunable LC-fiber

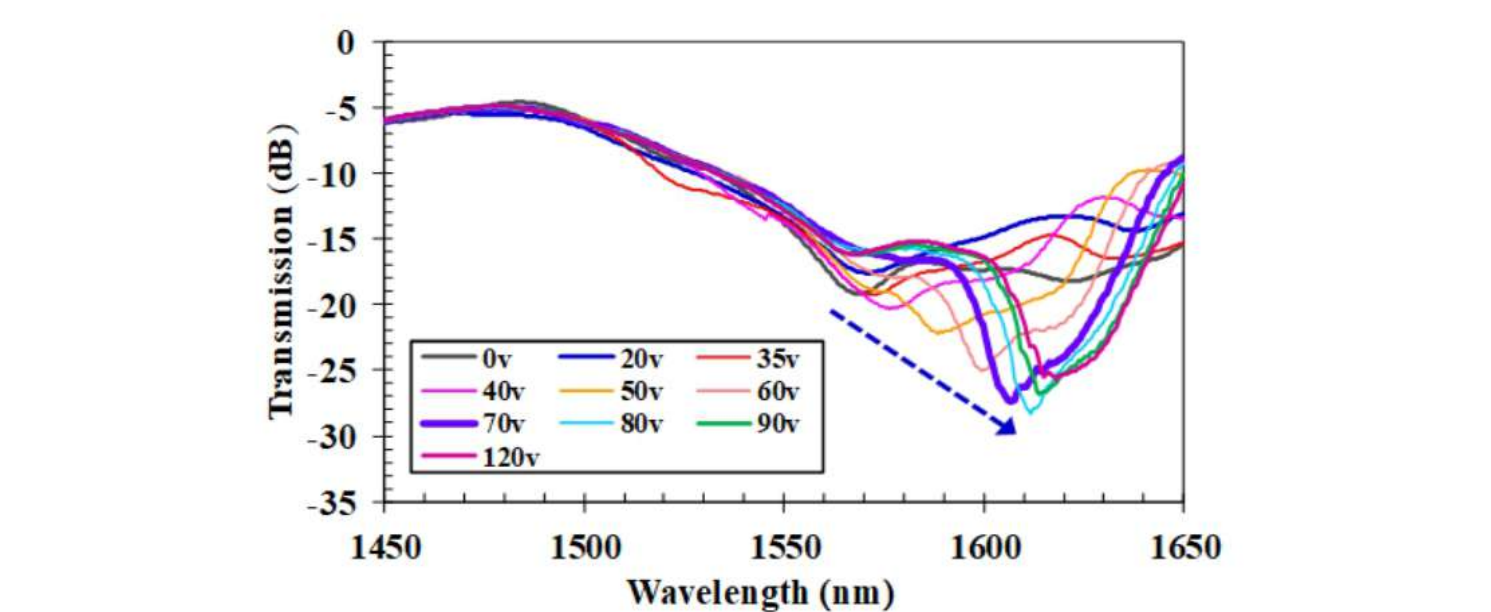
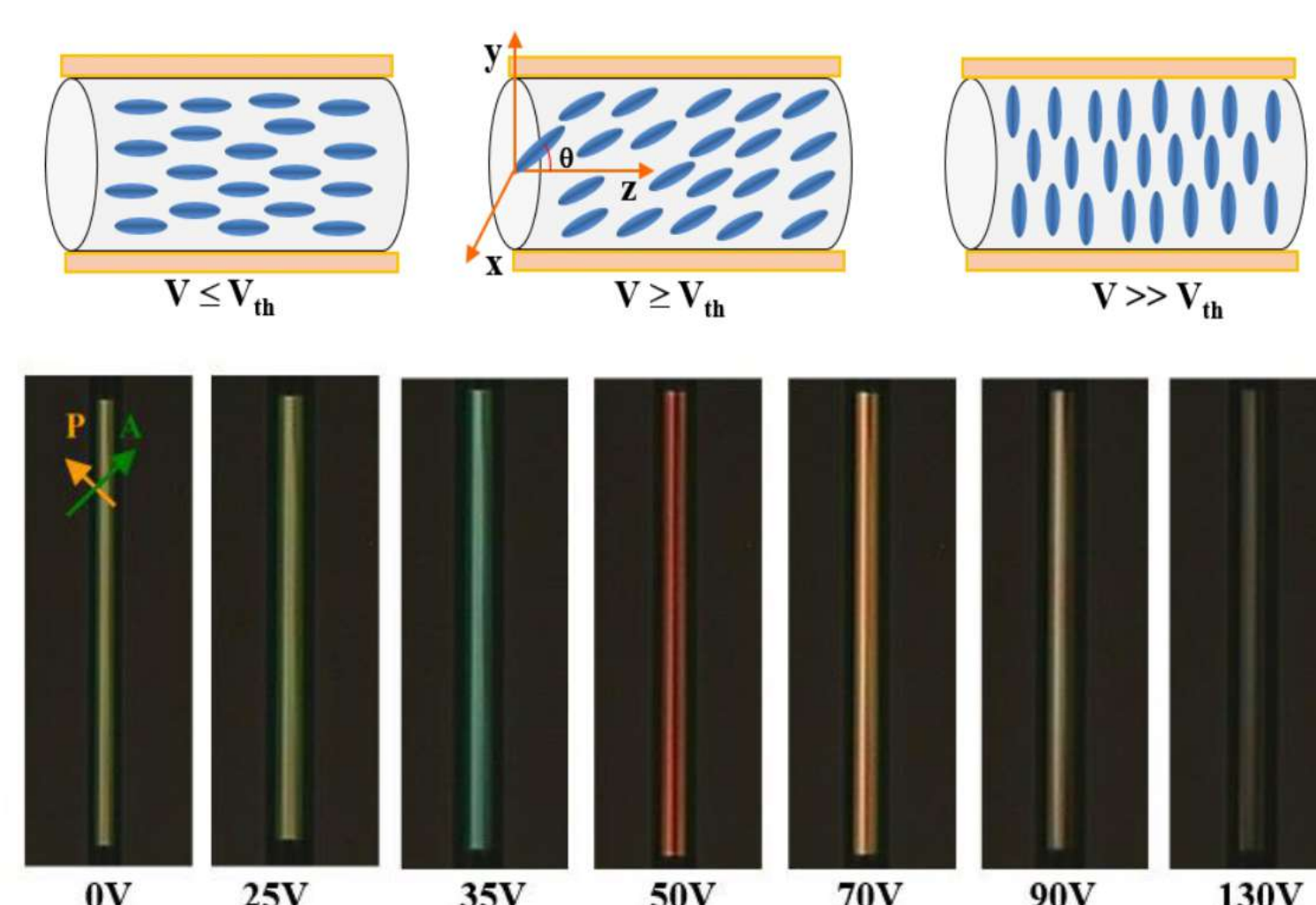

➤ LC-Tilted long period fiber grating

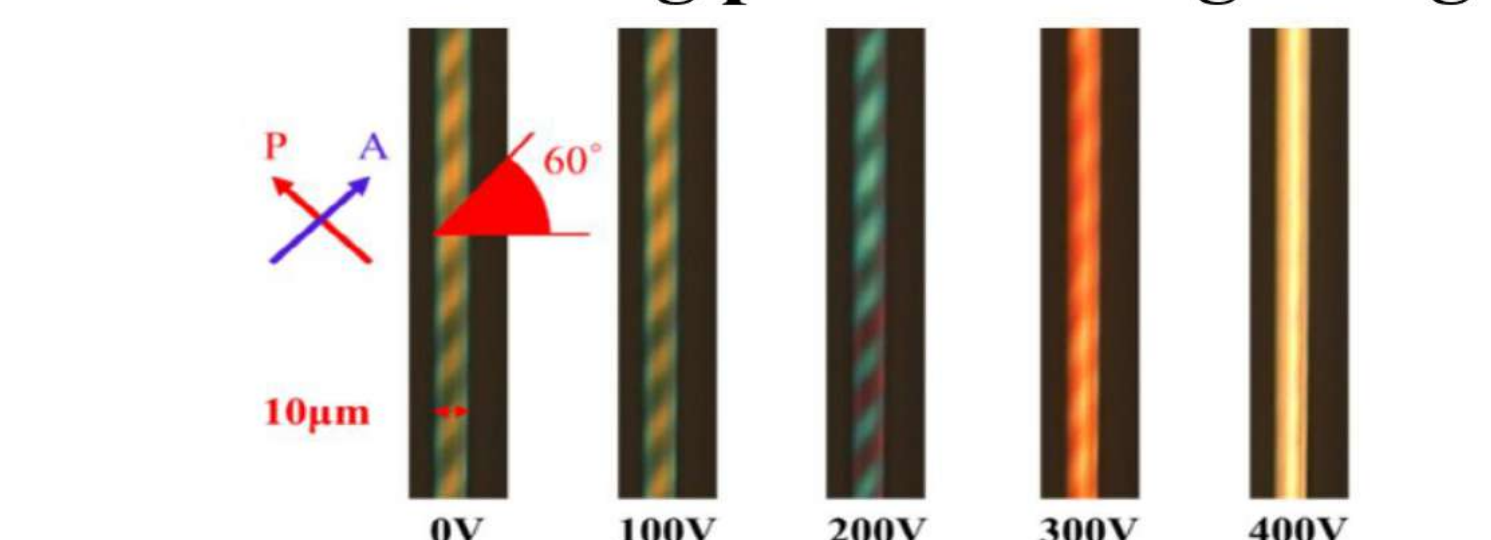

藍相液晶/高分子複合結構

- Photo-polymerisation-induced phase separation
- Blue phased liquid crystal/polymer composites-based photonic devices
- BPLC-based long period fiber grating

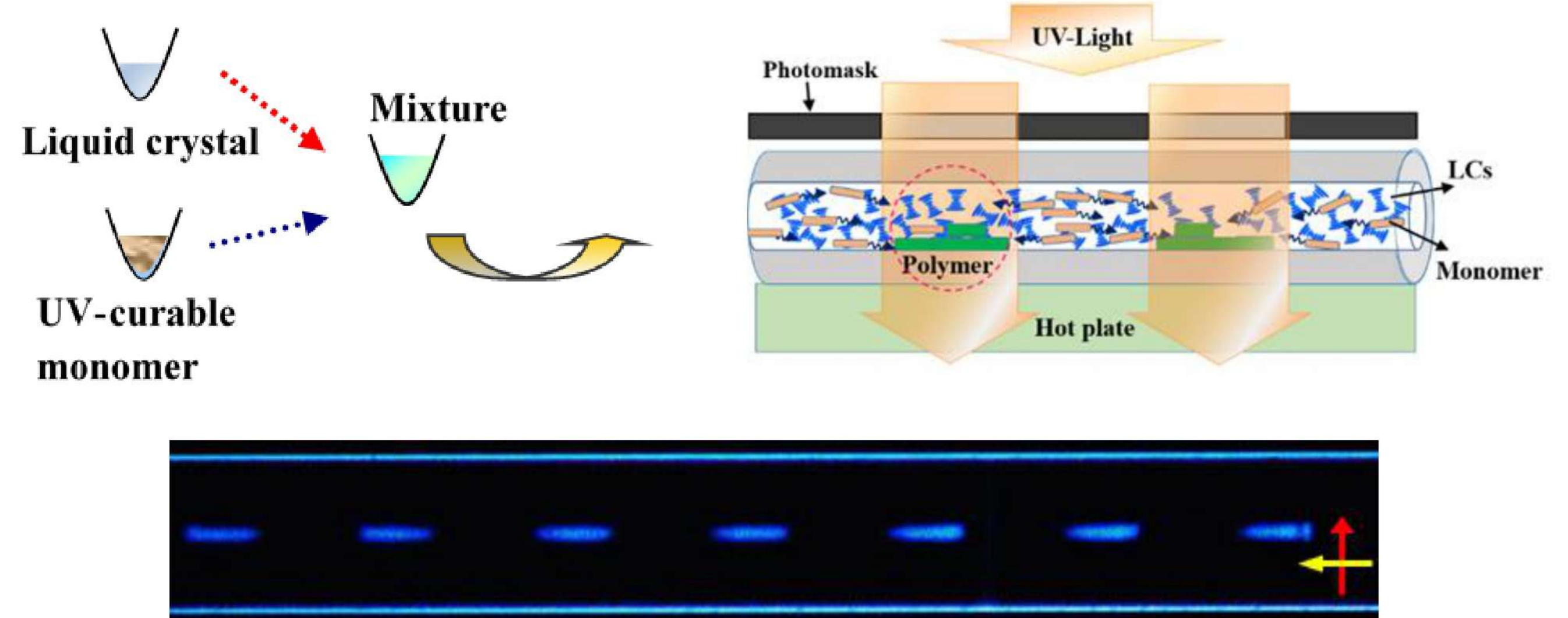

➤ Tunable Fresnel lens

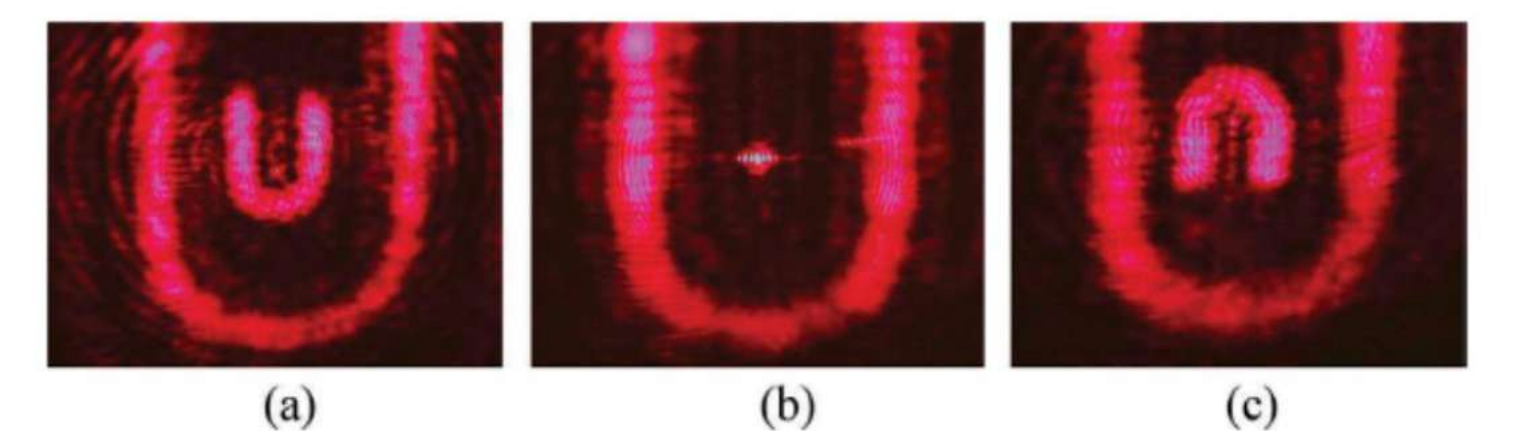
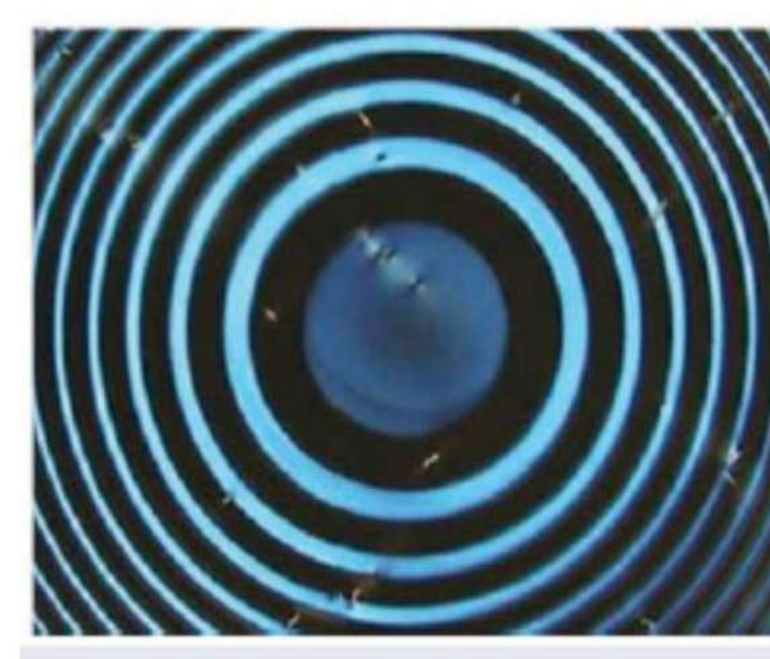
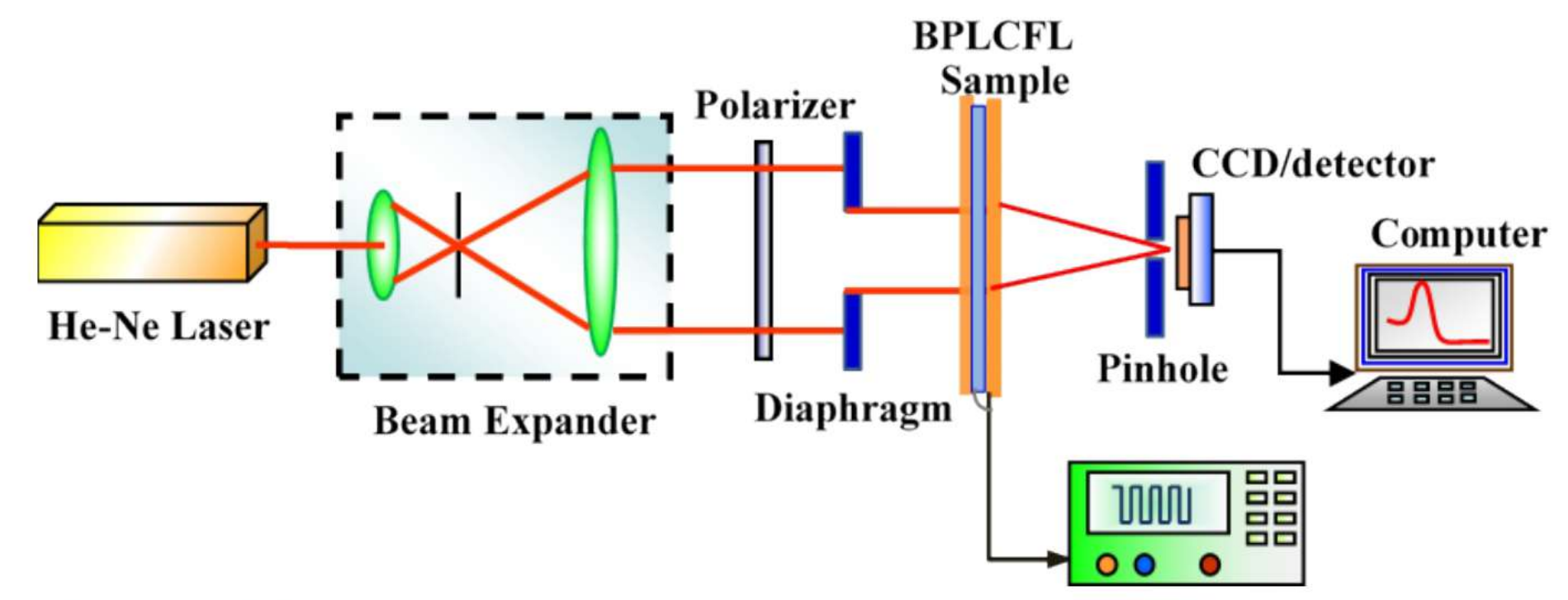
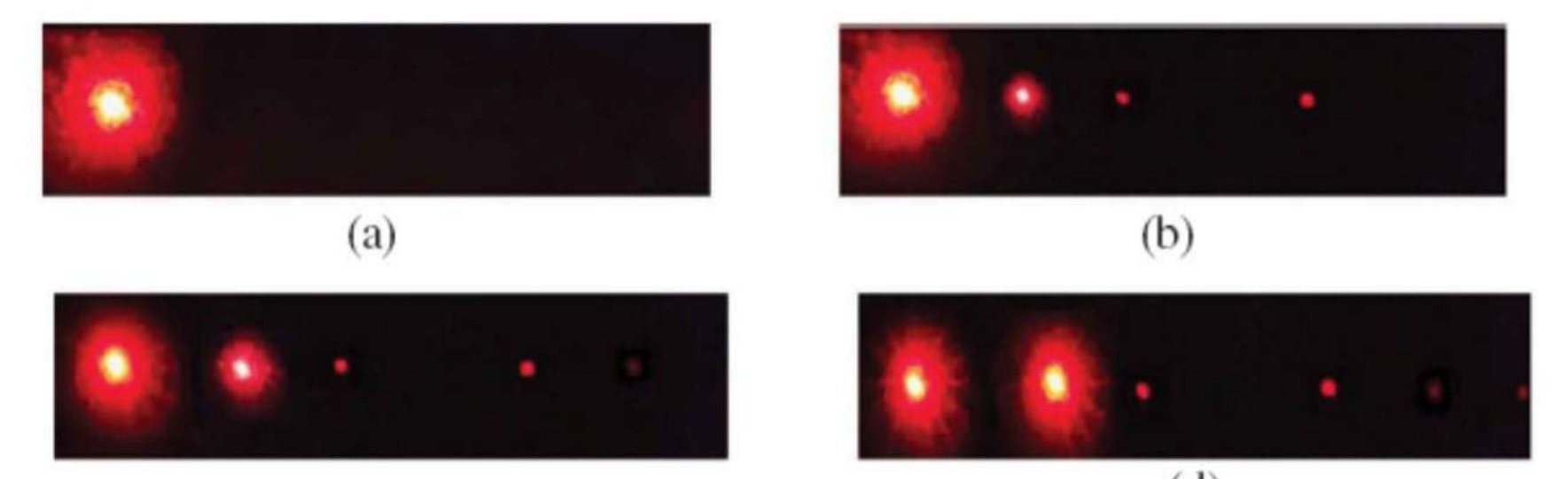
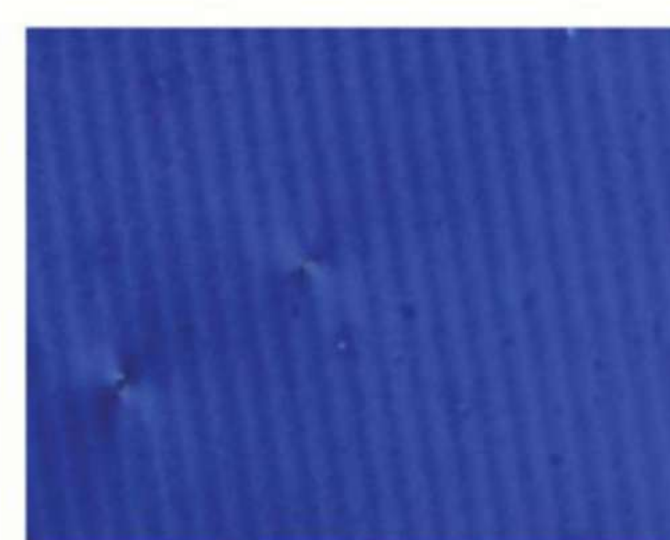

Image of BPLC Fresnel lens recorded by a CCD camera placed (a) 5 cm before the focal point, (b) at the focal point and (c) 5 cm after focal point

➤ Tunable Grating



Diffraction patterns at (a) V = 0, (b) 50 V, (c) 80V, (d) 120 V

電控液晶光電元件

- Tunable Liquid crystal devices- smart window, tunable polarizer, microlens, laser, ...etc.

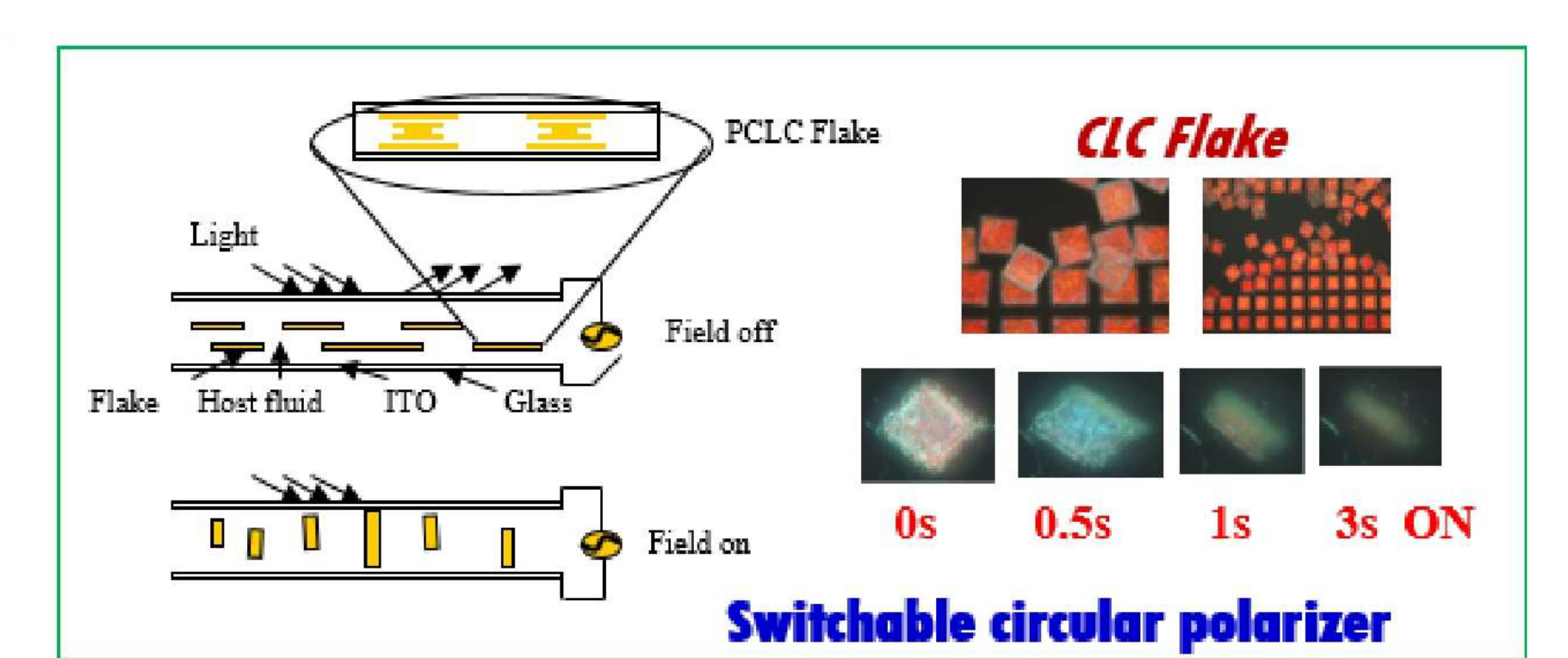
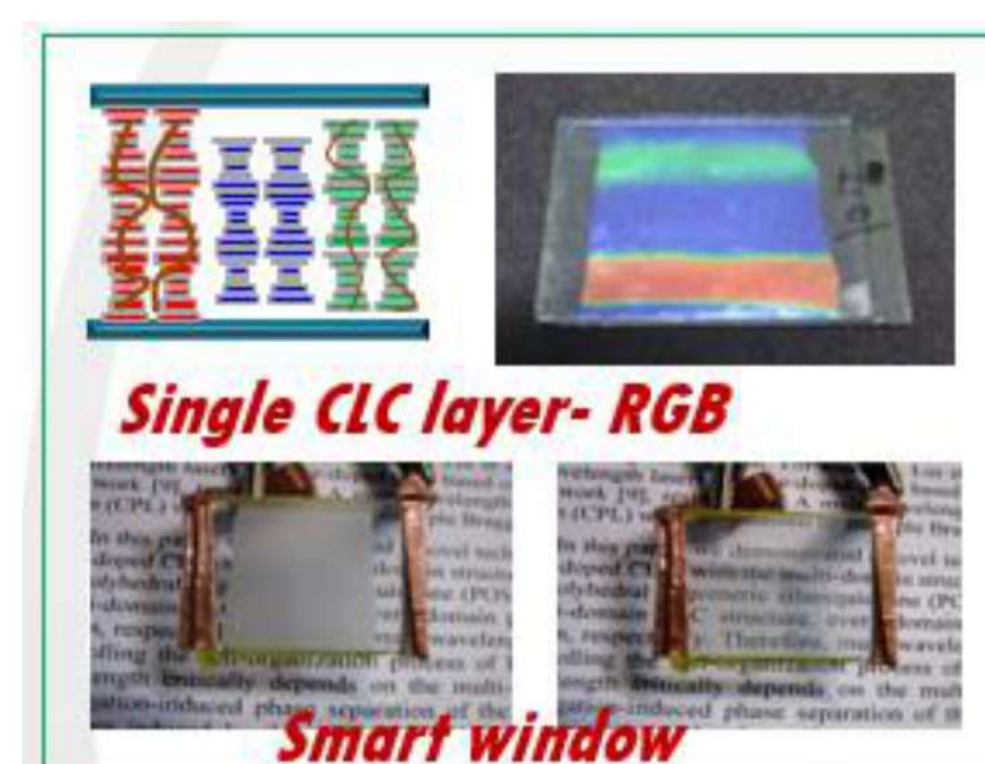

➤ Polarization-free Fresnel Lens

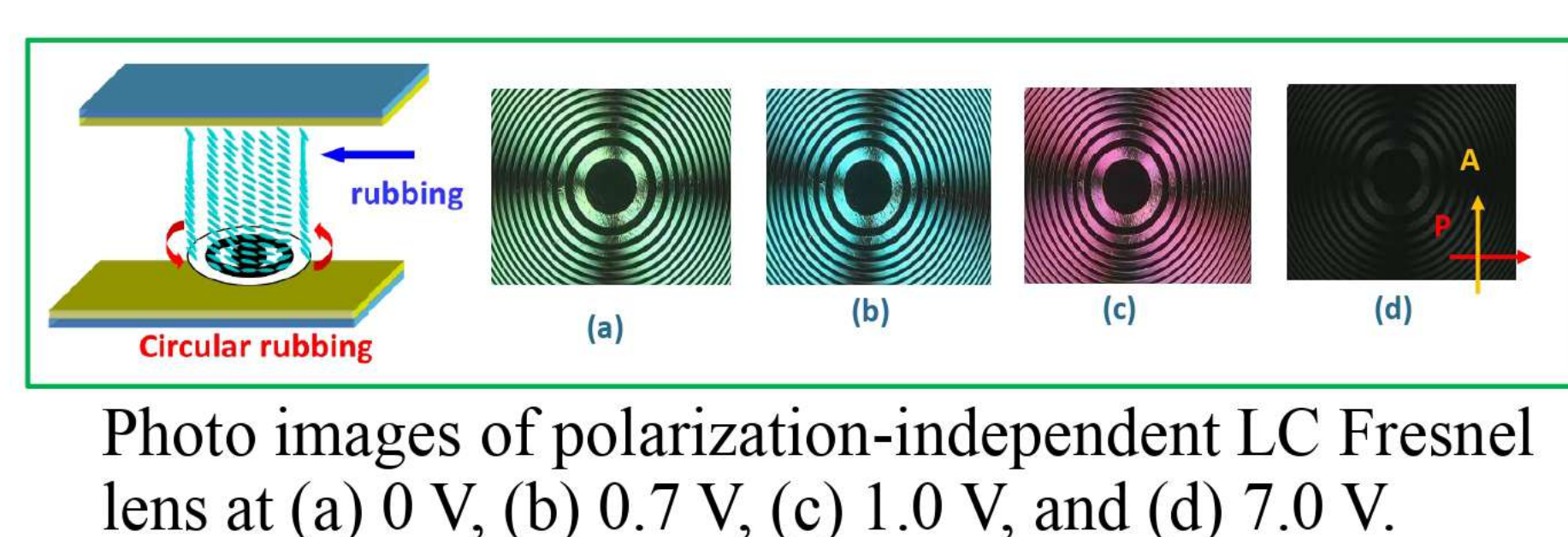
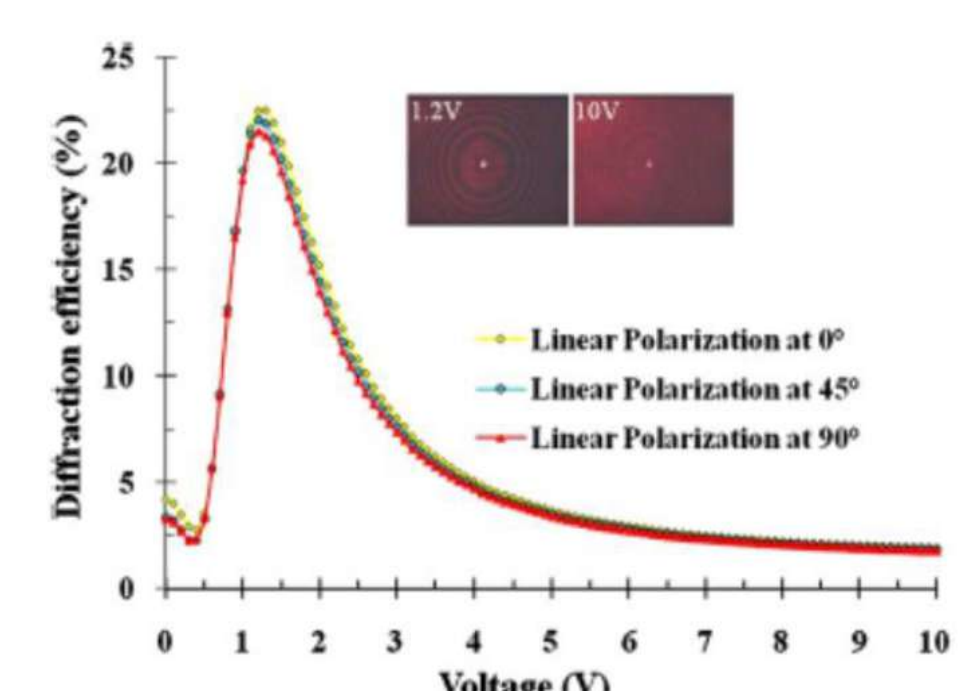
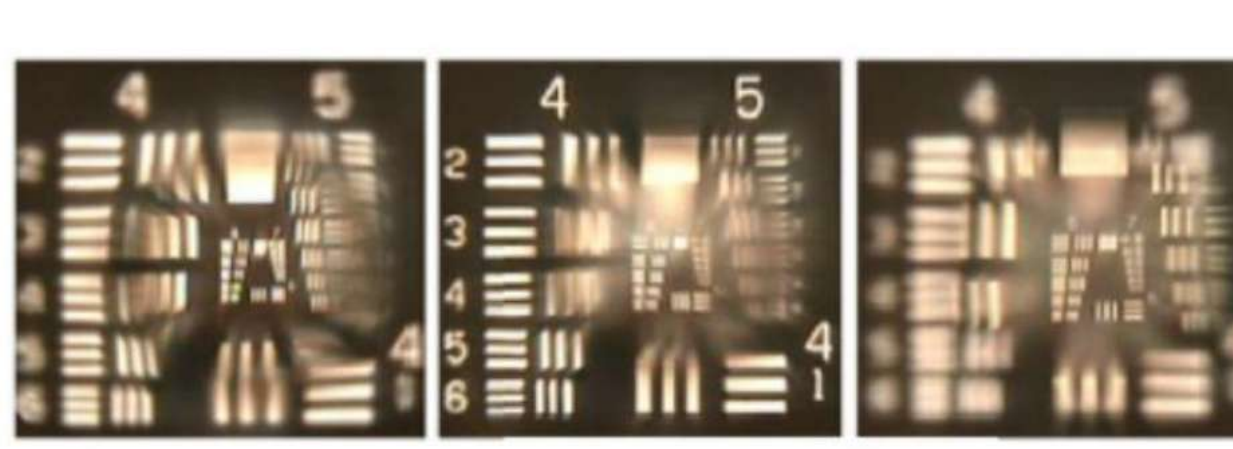

Photo images of polarization-independent LC Fresnel lens at (a) 0 V, (b) 0.7 V, (c) 1.0 V, and (d) 7.0 V.



➤ Tunable Microlens



Imaging behavior of the LC microlens under different applied voltages